

BULLETIN 931

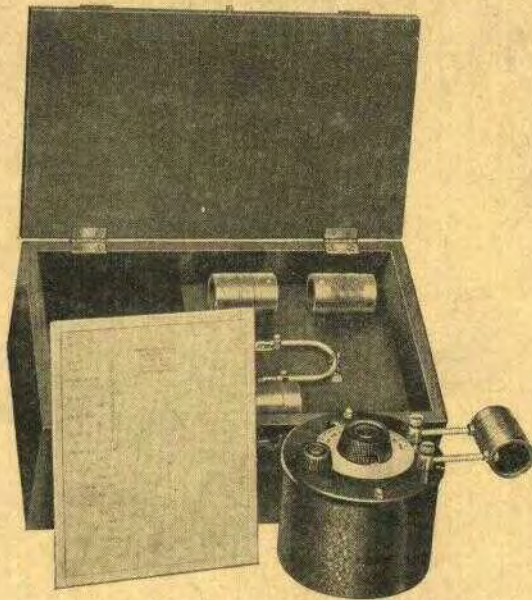

GENERAL RADIO

Quality Apparatus



MANUFACTURED BY THE

GENERAL RADIO CO.

30 STATE STREET

CAMBRIDGE, MASS., - U. S. A.

PRINTED IN U. S. A.

OCTOBER, 1926

FOREWORD

The General Radio Company was founded in 1915 to manufacture laboratory apparatus. The list of items included, in addition to the more technical ones, such articles as vacuum-tube sockets, rheostats, etc. With the advent of broadcasting these latter articles became in great demand.

Distribution was originally on a direct to the consumer basis. We found it necessary to accede to the changed conditions and raised our prices so that distribution could be through the jobber and dealer channels.

With the development of complete receivers, the use of the separate parts has again become confined largely to the engineer experimenter, either in his professional activities, or as a hobby. This class of consumer enjoys a trade discount because he does not require the services of a retail dealer. In effect, therefore, list prices are fictitious since they are made large enough to permit a discount to engineer buyers.

With the more limited use of radio component parts, jobbers have not always found it economical to carry the full list of items required by the experimenter. This is particularly true with such a complete and diversified line as that of the General Radio Company.

In order that our engineer customers may obtain those items they desire with a minimum of inconvenience, we have discontinued the sale of our products through jobbers and dealers. Instead, we have arranged a plan of prompt shipment on a factory to consumer basis. We are carrying adequate stocks and are maintaining an engineering staff to handle technical correspondence.

Prices have all been revised downward, so as to give all customers the advantage of a dealer discount. The prices as they now appear in this catalog are, therefore, strictly net and are not subject to discount.

Unless credit has been established, all shipments are made on a C. O. D. basis. While prices are F. O. B. our factory at Cambridge, Massachusetts, or from our San Francisco, California, warehouse, we will prepay transportation charges on United States and Canadian shipments whenever cash accompanies the order.

Prices have been revised to October 1, 1928, but are subject to change without notice. Shipment will, however, not be made at higher prices than those given in an order without further confirmation.



**TYPE 585
AMPLIFIER TRANSFORMERS**

The Type 585 Amplifier Transformers are intended for use where the best in transformer design is desired. They possess unusually good frequency characteristics. The Type 585-D Amplifier Transformer has a flat characteristic from 80 to 7000 cycles. At 30 cycles the amplification is 85% of the maximum value. In the Type 585-H Amplifier Transformer the band of uniform amplification is somewhat narrower but a higher amplification ratio (1:3.5) is obtained.

The use of adequate quantities of annealed silicon steel as the core material results in a high input impedance at low frequencies. Precautions against overload are not necessary since no permanent damage will result from saturation of the core, as is the case when nickel alloys are used as the core material. These transformers are designed for use with tubes of plate impedance not exceeding approximately 10,000 ohms.

Specifications	Type 585-D	Type 585-H
Primary Inductance	79 Henrys	71 Henrys
Primary D.C. Resistance	2000 Ohms	2000 Ohms
Secondary Inductance	316 Henrys	866 Henrys
Secondary D.C. Resistance	9300 Ohms	11,000 Ohms
Amplification Ratio	1:2	1:3.5
Permissible Primary Current	5 MA.	5 MA.
Code Word:	TIMID	TIPSY
Type 585 Amplifier Transformer	\$7.00

Dimensions, both types, 4 1/2" x 3 1/2" x 2 3/4". Weight 2 1/4 lbs.



GENERAL RADIO PARTS AND ACCESSORIES

TYPE 541 PUSH-PULL TRANSFORMERS

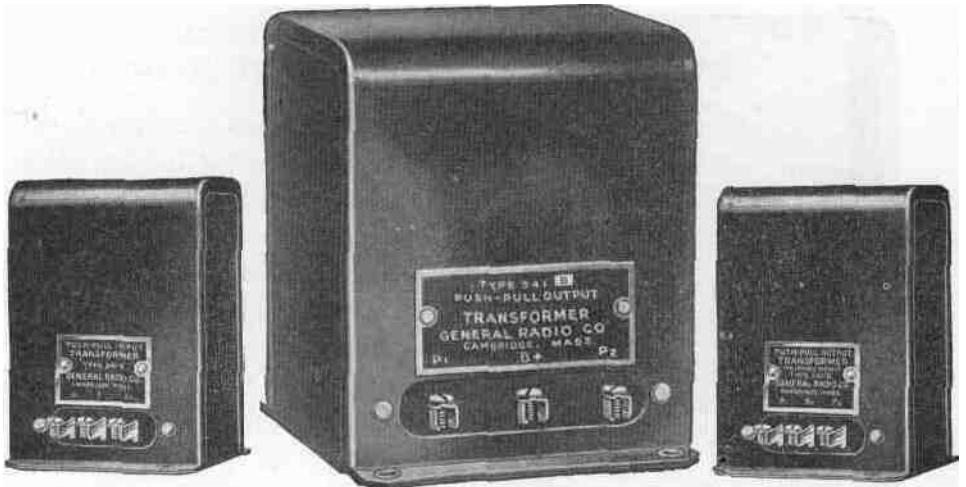

TYPE 541-A

TYPE 541-B

TYPE 541-C

The Type 541-A Input Transformer utilizes a sandwich type of coil in its construction which results in an unusually good characteristic. The curve is flat from 100 to 10,000 cycles, dropping to about 75% of the maximum at 30 cycles.

The Type 541-B and Type 541-C Output Transformers are designed for use with power tubes having plate impedances of 2,000 to 6,000 ohms and plate current not in excess of 55 milliamperes per tube.

Specifications	Type 541-A	Type 541-B
Primary Inductance	65 Henrys	36 Henrys
Permissible Primary Current	6 MA.	60 MA. each side
Turns Ratio (primary to whole secondary) 1:3		
Primary D.C. Resistance	1750 Ohms	750 Ohms (whole)
Dimensions	414" x 31/2" x 3"	414" x 3 5/8" x 41/2"
Weight	214 lbs.	8 lbs.

The electrical specifications for the Type 541-C Output Transformer are the same as for the Type 541-B Output Transformer, except for the turns ratio, which is 35:1 (whole primary to secondary). The case dimensions are the same as for the Type 541-A Input Transformer. Type 541-A and Type 541-B Push-Pull Amplifier Transformers

for Standard Speaker (2,000 to 3,000 ohms) Per Pair. . . . \$25.00
Code Word: TALLYTORSO.

Type 541-A and Type 541-C Push-Pull Amplifier Transformers
for Dynamic Speaker (5 to 10 ohms) Per Pair. \$25.00
Code Word: TALLYTAPER.

The Type 541 Transformers are licensed by the Radio Corporation of America and associated companies for radio amateur, experimental and broadcast reception only.



The **UNIVERSAL STANDARDS** of RADIO



**TYPE 285
AMPLIFIER TRANSFORMERS**

These transformers, while having a narrower uniform amplification band, require less space in a radio set and are lower in price than the Type 585 Amplifier Transformers. These transformers have enjoyed a very wide popularity in experimental radio sets.

They are encased in a black-japanned case impregnated with wax. This type of construction minimizes the danger of damage to the windings due to climatic conditions.

Specifications	Type 285-H	Type 285-D
Turns Ratio	1:6	1:2.7
Primary Inductance	15 Henrys	43 Henrys
Primary D.C. Resistance	1200 Ohms	2200 Ohms
Secondary Inductance	525 Henrys	300 Henrys
Secondary D.C. Resistance	13,000 Ohms	9000 Ohms
Code Word:	TOKEN	TOTEM
Type 285 Amplifier Transformer		.\$4.00
Dimensions, both types, 3 1/2" x 3 1/4" x 2 1/2".	Weight 1 1/2 Ibs.	

**TYPE 373
DOUBLE-IMPEDANCE COUPLER**

The Type 373 Double-Impedance Coupler incorporates two chokes and a coupling condenser mounted within a steel case making a coupling unit for insertion between the plate and grid circuits of successive amplifier tubes.

Each choke has an inductance of 55 henrys and a direct-current resistance of 1500 ohms. The capacity of the coupling condenser is 0.1 MF.

Type 373 Double-Impedance Coupler. . . \$4.50
Dimensions 4 1/2" x 3 1/2" x 3".

Weight 2 1/2 Ibs"

Code Word: JELLY.

This coupler is manufactured under U. S. Patent 1,589,692.



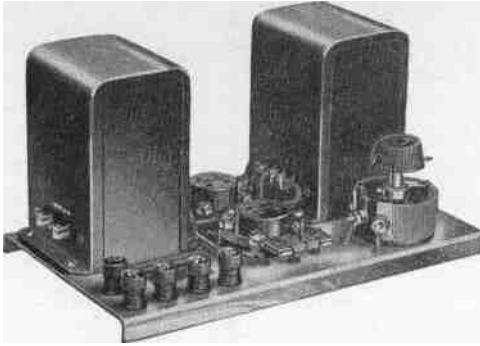

**TYPE 441
PUSH-PULL AMPLIFIER**

The Type 441 Push-Pull Amplifier is designed for use with power tubes, such as the 112, 226, 171 and 210 types. It is a completely assembled and wired unit including a metal baseboard, sockets and

rheostats, ready for installation. For the 171 type of tube a signal voltage of about 15 is required on the transformer primary, while for the 112 or 226 type of tubes the input signal voltage should be about 6.

The inductance of the input transformer is 30 henrys. Its turns ratio is 1:2.25 for each side. The D.C. resistance of the primary of this transformer is 1600 ohms.

The impedance ratio for the output transformer is 10:1 (whole primary to secondary). The D.C. resistance of the primary of the output transformer is 850 ohms.

Type 441 Push-Pull Amplifier \$15.00
Dimensions 9" x 5 1/4" x 5". Weight 5 1/2 lbs.

Code Word: ASIDE.

The Type 441 Unit is licensed by the Radio Corporation of America and associated companies for radio amateur, experimental and broadcast reception only.



TYPE 369 IMPEDANCE

The Type 369 Impedance is suitable for use in impedance-coupled amplifiers, in parallel plate-feed systems, and where an iron-cored inductance is used to prevent low-frequency interaction between circuits.

The inductance without a D.C. component is 98 henrys; the D.C. resistance is 1750 ohms, and the permissible current, 10 milliamperes.

Type 369 Impedance \$2.50
Dimensions 3 1/2" x 3 1/4" x 2 1/2". Weight 1 1/2 lbs.

Code Word: TONIC.





**TYPE 585-0
OUTPUT TRANSFORMER**



The Type 585-0 Output Transformer is intended for use between the plate circuits of power tubes of 2000 to 5000 ohms impedance, and dynamic speakers having an impedance of 5 to 10 ohms. This transformer will operate without impairment of audio quality with a direct current of 55 milliamperes in the primary and is, therefore, adapted

for use with the 250 type of tube. This transformer is identical in size and appearance with the Type 541-A Push-Pull Amplifier Transformer. It has a primary D.C. resistance of 464 ohms and a Secondary D.C. resistance of 1.87 ohms. Its turns ratio is 25:1.

Type 585-0 Output Transformer \$7.00

Dimensions 4 1/2" x 3 1/2" x 2 3/4". Weight 2 1/4 lbs.

Code Word: TITLE.

**TYPE 367
OUTPUT TRANSFORMER**



The Type 367 Output Transformer is intended for use where a slight change in the apparent load impedance is desired, in addition to keeping direct current out of the speaker windings. It is intended for use in the plate circuits of 6000 to 10,000-ohm tubes, and its impedance ratio of 1.5:1 makes it suitable for feeding 4000 to 5000-ohm speakers from such a tube.

This transformer has a primary inductance of 9.9 henrys and a primary D.C. resistance of 300 ohms. It has a secondary inductance of 8.2 henrys and a secondary D.C. resistance of 367 ohms. The direct current through the primary should not exceed 10 milliamperes.

Type 367 Output Transformer \$3.50

Dimensions 3 1/2" x 3 1/4" x 2 1/2". Weight 1 1/2 lbs.

Code Word: TESTY.



**TYPE 585-M
SINGLE-BUTTON MICROPHONE-TO-GRID TRANSFORMER**

A high-quality transformer of the proper impedance ratio is re- quired to adjust the l

to the grid impedance of the first-stage amplifier tube. The Type 585-M Single-Button Microphone-to-Grid Transformer is designed to fill these requirements. This transformer has a primary inductance of 0.95 henrys and a primary D.C. resistance of 20 ohms. The turns ratio is 1:27.

Type 585-M Single-Button Microphone-to-Grid Transformer. . . \$12.00

Dimensions 4 1/2" x 3 1/2" x 2 3/4". Weight 2 1/4 lbs.

CodeWord: TARDY.

**TYPE 585-M2
DOUBLE-BUTTON MICROPHONE-TO-GRID TRANSFORMER**

Whenever a double-button microphone is used, a split winding is required on the primary of the transformer. The Type 585-M2 Double-Button Microphone-to-Grid Transformer is similar in its general characteristics to the Type 585-M Transformer, except that proper provision has been made for the use of a double-button microphone. Each winding of this transformer has a primary inductance of 0.95 henrys and a primary D.C. resistance of 32 ohms.

Type 585-M2 Double-Button Microphone-to-Grid Transformer. \$12.00

Dimensions 4 1/2" x 3 1/3" x 2 3/4". Weight 2 1/4 lbs.

CodeWord: TARRY.

**TYPE 284
LINE-AMPLIFIER TRANSFORMERS**

The Type 284 Line-Amplifier Transformers are designed for use with line amplifiers, as the coupling unit between the plate of an amplifier tube and the line, and between the line and the grid of an amplifier tube. They are designed for a 500 to 600-ohm line impedance.

Type 284-D Plate-to-Line Coupling Transformer \$12.00

Turns ratio 3.6:1

Code Word: PETTY.

Type 284-E Telephone Line-to-Grid Coupling Transformer. . . . \$12.00

Turns ratio 1:7.3

CodeWord: PIGMY.

Dimensions 4 1/2" x 3 1/2" x 2 3/4". Weight 2 1/4 lbs.

**TYPE 587-B
SPEAKER FILTER**

The Type 587-B Speaker Filter is intended for use in the output of such power tubes as the 250 type where the plate current is large, but the tube impedance is so low that no adjustment of impedance is needed. The Type 587-B Speaker Filter is suitable for use following impedances of 2000 to 10,000 ohms. Where a dynamic speaker is used as a load, a Type 585-0 Output Transformer would be required.



The Type 587-B Speaker Filter contains a choke coil of 15 henrys inductance and 175 ohms D.C. resistance. The direct current through the coil should not exceed 100 milliamperes. A 4-MF. condenser is connected in each speaker lead.

Type 587-B Speaker Filter \$9.00
 Dimensions 4 1/4" x 3 5/8" x 4 1/2". Weight 4 lbs.
 Code Word: FATAL.

**TYPE 387-A
SPEAKER FILTER**

In installations where the plate current does not exceed 20 to 30 milliamperes, such as when the 112, 171 or 210 type of tube is used, a speaker filter of lower current capacity may be used. The Type 387-A Speaker Filter fills the requirements of such installations. It contains a choke coil of 30 henrys inductance and 350 ohms D.C. resistance. The direct current through the coil should not exceed 30 milliamperes. A 2-MF. condenser is connected in the speaker lead.



Type 387-A Speaker Filter \$4.50
 Dimensions 4 1/4" x 3 1/2" x 3". Weight 2 1/2 lbs.
 Code Word: TOWEL.





TYPE 565 TRANSFORMERS

The Type 565 Transformers are intended for use in high-voltage power equipment for supplying such tubes as the 210 or 250 types, and for use in amateur transmitters. These transformers have a 200-watt rating. They are designed for operation from 105 to 125-volt, 50 to 60-cycle lines, and are available with the following secondary voltages based on 115 volts primary input.



Type 565-A Half-Wave Transformer	\$18.50
Secondary voltages	600 Volts 7.5 Volts 7.5 Volts 2.5 Volts	
Maximum current	200 MA. 3.5 Amperes 2.5 Amperes 4 Amperes	
CodeWord: TABOO.		

Type 565-B Full-Wave Transformer	\$13.50
Secondary voltages	1200 Volts (with center tap) 7.5 Volts 7.5 Volts	
Maximum current	200 MA. 2.5 Amp. 2.5 Amp.	
Dimensions, both types, 53/4" x 51/4" x 51/4". Weight 141/4 lbs.		
Code Word: TACIT.		

**TYPE 527-A
RECTIFIER FILTER**

The Type 527-A Rectifier Filter is a complete filter for heavy-duty plate-supply units, incorporating two chokes and a condenser assembly of 4-2-4 MF. Each choke has an inductance of approximately 15 henrys, and a current-carrying capacity of 100 milliamperes. The D.C. resistance is 175 ohms for each choke. The condensers are rated at 1000 volts continuous service. The filter is similar in appearance to the Type 565 Transformers.



Connections are in the form of flexible leads. It is mounted in a drawn-steel case with black-japan finish.

Type 527-A Rectifier Filter	\$17.50
Dimensions 53/4" x 51/4" x 51/4". Weight 91/2 lbs.		
Code Word: FATTY.		



**TYPE 365
PLATE-SUPPLY TRANSFORMER**



For low-voltage plate supplies, intended for service with amplifiers using the 171 type of power tube, a power transformer of lower voltage and power rating than the Type 565 Transformer is required. The Type 365 Plate-Supply Transformer is designed for use as a power-supply transformer in such equipment. It is intended for use on 105 to 125 volt, 50 to 60-cycle lines. The power rating is 70 watts. Secondary voltages are 550 (100 milliamperes)

with a center tap, and 7.5 (2.5 amperes).

Type 365 Plate-Supply Transformer \$6.00

Dimensions 4 1/2" x 3 5/8" x 4 1/2". Weight 4 1/2 lbs.

Code Word: TENOR.

**TYPE 440-A
LOW-VOLTAGE TRANSFORMER**

The Type 440-A Low-Voltage Transformer, which is similar in appearance to the Type 365 Transformer, is primarily intended for filament supply of alternating-current tubes. Like the other power transformers, it is designed for use on 105 to 125-volt, 50 to 60-cycle lines. The power rating is 70 watts. The following voltages are available: 2—3.5—5—7.5. All windings are separate.

Type 440-A Low Voltage Transformer \$7.00

Dimensions 4 1/4" x 3 5/8" x 4 1/2". Weight 4 1/2 lbs.

Code Word: TIGER.

**TYPE 366
FILTER:CHOKE**

Low-frequency filters, particularly those of the "brute-force type" used in plate-supply units, require a filter inductor of large inductance and current-carrying capacity.

The Type 366 Filter Choke is such a unit. It consists of two 30-henry chokes, each brought out to separate connections. The D.C. resistance is 350 ohms per choke.

Type 366 Filter Choke \$5.00

Dimensions 4 1/4" x 3 5/8" x 4 1/2"

Weight 4 3/4 lbs.

Code Word: TEPID.





**TYPE 445
PLATE-SUPPLY AND GRID-BIAS UNIT**

The Type 445 Plate-Supply and Grid-Bias Unit has been designed to meet the demand for a thoroughly dependable light socket "B" power unit that is readily adaptable to the requirements of standard tubes. Any combination of voltages from 0 to 180 may be taken from the four positive "B" terminals. An adjustable grid-bias voltage from 0 to 50 is also available for use on the power tube of an amplifier.

Voltages are varied by moving adjustable clamps with thumbscrews along a wire-wound resistance. When the clamps are set for the proper operating voltages of the tubes, the thumbscrews are tightened and voltages will remain constant, but may easily be readjusted to meet new requirements.

To make the unit absolutely safe even in the hands of persons not familiar with electrical devices, an automatic cut-out switch is provided which breaks the 110-volt A.C. circuit when the cover is removed for adjusting voltages or connecting wires to binding posts. The Type 445 Plate-Supply and Grid-Bias Unit is designed for use on 105 to 125-volt, 50 to 60-cycle lines, and uses the 280 type of rectifier tube.

Type 445 Plate-Supply and Grid-Bias Unit without tube \$35.00

Dimensions 15 1/4" x 1" x 7". Weight 16 lbs.

Code Word: APPLE.

This unit is licensed by the Radio Corporation of America and associated companies for radio amateur, experimental, and broadcast reception only.

**TYPE 400
PLATE-SUPPLY AND SINGLE-STAGE POWER AMPLIFIER**

The Type 400 Plate-Supply and Single-Stage Power Amplifier furnishes a complete stage of power amplification, as well as plate power, for the entire receiver. The power amplifier uses the 171 type of tube. The rectifier tube is the 280 type. This unit operates from 105 to 125-volt, 50-60 cycle A.C. lines and provides voltages of 45, 90 and 135 volts, and a high plate voltage of 180 volts, together with the necessary grid bias for the power tube.



Voltages are secured by means of fixed resistances. The voltage drops per milliampere load are as follows:

Tap	Open Circuit	Voltage Drop Per Milliampere
45	50	2.35 Volts
90	118	2.35 Volts
136	179	2.92 Volts

Type 400 Plate-Supply and Single-Stage Power Amplifier,
without tubes\$ 35.00

Dimensions 15 1/4" x 7" x 7". Weight 18 1/4 Ibs.

CodeWord: ANNUL.

This unit is licensed by the Radio Corporation of America and associated companies for radio amateur, experimental, and broadcast reception.

- Type UX-280 or CX-380 Rectifier Tube\$4.25
- Type UX-226 or CX-326 Amplifier Tube 2.25
- Type UX-112-A or CX-112-A Amplifier Tube 2.75
- Type UX-171-A or CX-371-A Amplifier Tube 2.75
- Type UX-210 or CX-310 Amplifier Tube 9.00

TYPE 558 AMATEUR-BAND WAVEMETER



The increased congestion and decrease in width of the amateur bands make necessary the use of a more accurate wavemeter than has heretofore been available to amateurs at a low price. To meet this need the General Radio Company has developed a band-type wavemeter which employs a system used in broadcast station frequency meters in order to secure great precision over a limited band.

In the Type 558 Amateur-Band Wavemeter a fixed air condenser is connected in parallel with the variable condenser. This arrangement spreads a narrow band of frequencies over the entire wavemeter scale which greatly increases the accuracy of reading. Five coils are used, covering the following amateur bands:

Coil A	4.6 to 5.4 Meters
Coil B	9.4 to 10.9 Meters
Coil C	18.5 to 21.5 Meters
Coil D	37.0 to 43.0 Meters
Coil E	75.0 to 86.0 Meters

A neon tube, mounted inside the condenser case and viewed through a hole in the panel, indicates resonance. The accuracy of calibration is to within 0.25%. When it is considered that this is the same precision as is guaranteed for the Type 224 Precision Wavemeter, the low price of this instrument is particularly striking.

A wooden case with a mounting rack for the coils and for the condenser is supplied with each wavemeter.

Type 558 Amateur-Band Wavemeter. \$20.00

Dimensions 11³/₄" x 7¹/₂" x 5¹/₂". Weight 4¹/₂ lbs.

Code Word: UNION.

TYPE 358 WAVEMETER

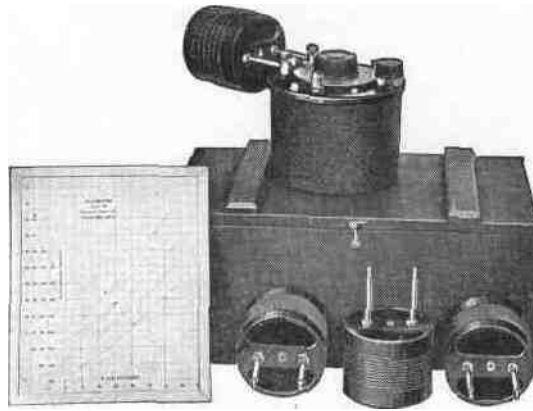

The General Radio Type 358 Wavemeter is designed particularly for experimenter use. It covers a wavelength range of approximately 14 to 220 meters, covering the short-wave bands in common use. The wavemeter consists of a mechanically rugged coil of low-loss construction, mounting directly on the binding posts of a shielded condenser. The condenser capacity is 125 MMF. Mounted on the condenser panel and connected in series between the condenser and coil is a resonance indicator in the form of a small lamp. The lamp socket is so arranged that it is short-circuited when the lamp is removed.

The wavelength range is covered by means of four coils. Each wavemeter is individually calibrated with an accuracy of within 1%. A calibration curve is plotted for each coil and the curve sheet mounted on a substantial metal backing. The coil ranges, providing adequate overlaps, are as follows:

Coil A	14 to 28 Meters
Coil B	26 to 56 Meters
Coil C	54 to 114 Meters
Coil D	105 to 220 Meters

The condenser, coils and chart are contained in a wooden box which provides proper protection for the instrument when not in use.

Type 358 Wavemeter complete \$15.00

Dimensions 113/4" x 7 1/4" x 5 1/2". Weight 4 1/2 Ibs.

Code Word: UPPER.

**TYPE 458
5-METER WAVEMETER**

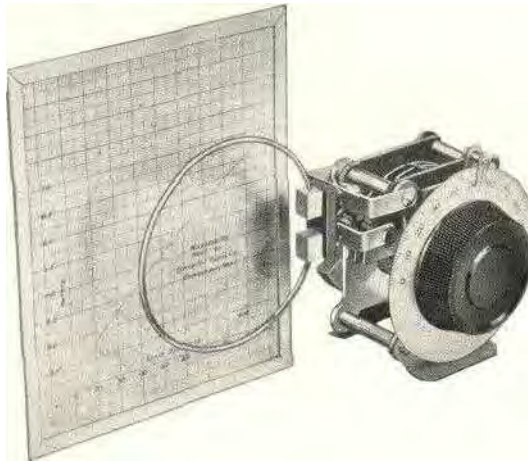

The recent developments in transmission at 5 meters (60,000 kilocycles) have made it desirable to have an accurate wavemeter covering that wavelength. The Type 458 5-Meter Wavemeter is supplied unmounted, having only brackets to support the condenser in an upright position. The condenser is of the usual soldered plate, metal-end-plate type, having a maximum capacitance of 50 MMF. The importance of soldered plates at this high frequency can hardly be over-emphasized. The coil consists of a single turn of 1/8" copper tubing, and is connected to the condenser by means of the convenient General Radio Plugs. The coil is silver-plated. A 4" dial and indicator completes the wavemeter. It is found that the metal end plates so completely shield the condenser that hand capacity is not troublesome. Like other General Radio Wavemeters, each has its individual calibration chart and is calibrated against a precision standard.

Type 458 5-Meter Wavemeter \$8.00

Dimensions 9" x 5 1/2" x 3 3/4". Weight 11 1/2 lbs.

Code Word: UMBER

**TYPE 247-W
WAVEMETER AND FILTER**

The range of the Type 247-W Wavemeter and Filter is 200 to 600 meters. Wavelengths are determined by direct readings from the condenser dial, which is calibrated with an accuracy of within 2%.

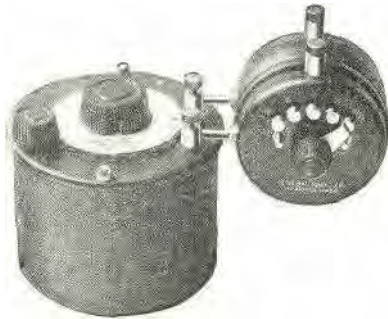

The filter coil may be connected either in series or parallel with the receiving set. When used in the series connection a single interfering broadcast station may be eliminated. The parallel filter is used to eliminate several interfering stations simultaneously and accept only one station within the filter range.

A full set of instructions accompanies each instrument.

Type	Description	Dimensions	Weight	Code Word	Price
247-W	Wavemeter and Filter	6" x 4 1/2" x 8"	2 1/2 lbs.	WAGON	\$7.00
247-W2	Extension Coil (400-1200 meters)	4" x 4" x 3"	6 oz.	VOCAL	2.75
247-W1/2	Extension Coil (100-300 meters)	4" x 4" x 3"	6oz.	VIZOR	2.75
247-W1/4	Extension Coil (50-150 meters)	4" x 4" x 3"	6 oz.	VIVID	2.75

**TYPE 276-A
QUARTZ PLATE**

The Type 276 Quartz Plates are intended primarily for use by amateurs in controlling the frequency of transmitters. These plates are not ground to specifications but are supplied to have a frequency somewhere in the band specified.



They are unmounted, but are calibrated to an accuracy of within 0.25%. These plates are licensed under Radio Corporation of America and associated companies and G. W. Pierce patents and patent applications.

Type 276-A 160 Quartz Plate. Unmounted. For use in 160-meter band. Price \$15.00

Code Word: LABOR.

Type 276-A 80 Quartz Plate. Unmounted. For use in 80-meter band. Price \$25.00

Code Word: LAYER.

Plate holder for Type 276-A Quartz Plate only. Price \$1.50

Code Word: LASSO.

VARIABLE AIR CONDENSERS

The General Radio Company has been very closely associated with condenser development and has contributed much to the science of radio in condenser design. In 1915 it supplied the first low-loss type of condenser. In 1922 the present low-loss soldered-plate type was introduced. In the soldered-plate type the rotors and stators are each soldered in specially constructed jigs uniformly spaced. This method of assembly not only insures accurate spacing but a low resistance and a permanent contact between plates. It also makes the entire assembly very rigid.

Both metal-end-plate and hard-rubber end-plate types are available. The rotor and stator units of both types are identical. In the metal-end-plate types the rotors are grounded to the end plates. The plates of the rotor and of the stator sections are each soldered together in a jig which accurately spaces the plates.

The equivalent series resistance of both types is about the same, approximately 0.3 ohms at 500 MMF. and at 1000 KC. The minimum capacity of all types range from approximately 15 MMF. on the small capacities to 25 MMF. on the larger sizes.

TYPE 247 CONDENSERS

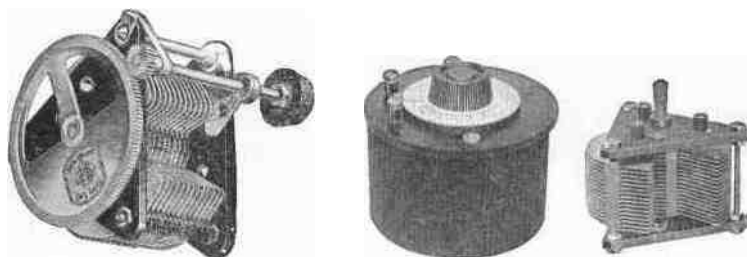

These are the condensers which stand out pre-eminently as the leaders of radio-frequency condensers and still sell at popular prices. The panel mounting models have straight-line wavelength plates. The case mounted models have straight-line capacity plates and dials with capacity calibrations. They make excellent standards for the experimenter.

Type	Capacity	Description	Dimensions	Weight	Code Word	Price
247-F	500 MMF.	Panel Mntg. with ctw.	4" x 4" x 4 1/2"	1 lb.	COCOA	\$3.00
247-H	500 MMF.	Panel Mntg. with gear	4" x 4" x 4 1/2"	1 1/8 lb.	COMIC	3.75
247-G	500 MMF.	Case Mtd. with gear	5" x 5" x 4 1/2"	2 1/4 lb.	COLIC	5.75
247-N	350 MMF.	Panel Mntg. with ctw.	4" x 4" x 4 1/8"	1 lb.	ABASE	2.75
247-P	350 MMF.	Panel Mntg. with gear	4" x 4" x 4 1/2"	% lb.	ABBEY	3.50
247-K	250 MMF.	Panel Mntg. with ctw.	4" x 4" x 4"	7/8 lb.	CARGO	2.50
247-M	250 MMF.	Panel Mntg. with gear	4" x 4" x 4"	7/8 lb.	CIGAR	3.25
247-L	250 MMF.	Case Mtd. with gear	5" x 5" x 5 1/3"	2 lb.	CAROM	5.25



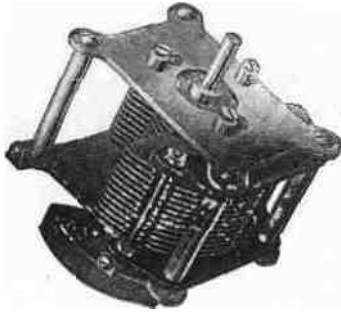

Type 334 Condenser

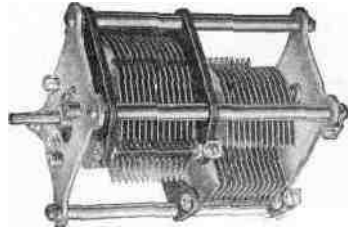

Type 374 Condenser

TYPE 334 CONDENSERS

Where the shielding effect of metal end plates is desirable the Type 334 Condensers are particularly recommended for use in receiving sets. They are of low-loss construction and very rugged.

The Type 334-T and V Condensers are similar in appearance to all other Type 334 Condensers except that they have double spacing for use in short-wave transmitters on voltages up to 2000. They are supplied with counterweights only.

Type	Capacity	Description	Dimensions	Weight	Code Word	Price
304-F	500 MMF.	Panel Mntg. with ctwt.	33/4" x33/4" x41/2"	11/2Ib.	BEGIN	\$3.25
334-H	500 MMF.	Panel Mntg. with gear	33/4" x33/4" x41/2"	11/2Ib.	BELAY	4.00
334-N	350 MMF.	Panel Mntg. with ctwt.	33/4" x33/4" x41/2"	11/2 Ib.	BESET	3.00
334-P	350 MMF.	Panel Mntg. with gear	33/4" x33/4" x41/2"	11/2 Ib.	BEVEL	3.75
334-K	250 MMF.	Panel Mntg. with ctwt.	33/4" x33/4" x41/2"	11/2Ib.	BELOW	2.75
334-M	250 MMF.	Panel Mntg. with gear	33/4" x33/4" x41/2"	11/2Ib.	BERYL	3.50
334-T	100 MMF.	Panel Mntg. without gear	33/4" x33/4" x4"	11/4Ib.	BILLY	2.75
334-V	50 MMF.	Panel Mntg. without gear	33/4" x33/4" x4"	11/4 Ib.	BIPED	2.50

TYPE 374 CONDENSERS

These condensers are similar in general construction to the Type 334 Condensers except that the plates are cut so as to give a straight-line frequency variation. A feature of this type of straight-line frequency condenser is that it requires no more panel space than the straight-line wavelength type of condenser and may be substituted for either the Type 247 or 334 Condensers since the mountings are exactly the same.

Type	Capacity	Description	Dimensions	Weight	Code Word	Price
374-B	125 MMF.	Single without gear	33/4" x33/4" x 31/4"	1 Ib.	BONUS	\$2.75
374-K	250 MMF.	Single without gear	33/4" x33/4" x 41/4"	11/8Ibs.	BOSOM	3.50
374-N	350 MMF.	Balanced without gear	33/4" x33/4" x5"	2 lbs.	BOXER	4.25
374-F	500 MMF.	Balanced without gear	33/4" x33/4" x6"	21/8 lbs.	BRAVO	5.00





TYPE 368
MICRO-CONDENSERS

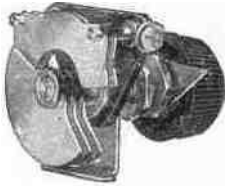

A small balancing or vernier condenser is required in some of the most recent circuits. For such use the Type 368 Single Hole Mounting Micro-Condensers are particularly recommended.

Type	Capacity	Description	Dimensions	Weight	Code Word	Price
368-A	12MMF.	Micro-Condenser	2"x2"x1 7/8"	2 oz.	BULLY	\$.75
368-B	50 MMF.	Micro-Condenser	2"x2"x2"	2 1/2oz.	BURIN	1.00

TYPE 557
SHORT-WAVE CONDENSER

In designing short-wave receivers it is desirable to cover only a comparatively narrow range of wavelengths on one coil in order to separate properly stations and to minimize the chance of "slipping over" a wanted signal. It is usual to accomplish this by the simple process of removing plates from a standard type of receiving condenser until its coverage is satisfactory to the operator.

A new condenser is now available for this particular use. It is the Type 557 Short-Wave Condenser as used in the Type 558 Amateur-Band Wavemeter. This condenser consists of six stator plates, two rotor plates of the straight-line wavelength type, and two additional rotor plates which are complete circular discs. These latter plates revolve with the shaft, but produce no change of capacitance. Hence they act as a fixed condenser, shunting a variable condenser. The minimum capacitance is approximately 43 MMF. and the maximum 70 MMF. The plates are widely spaced, the same as in our transmitting condenser, with the usual soldered-plate construction, insuring constancy of capacitance. The end plates are of hard rubber.

The tuning range of a receiver using this condenser will be such that it covers the 75 to 85-meter band with a small margin to spare and other bands in the same ratio. Any standard dial made for a 1/4 shaft may be used. It is supplied for panel mounting only, and without gear.

Type 557 Short-Wave Condenser \$3.25

Dimensions 4" x 4" x 4 1/2". Weight 1 lb.

Code Word: BEGOT.

All of the soldered-plate condensers listed above are made under U. S. Patent No. 1,542,995, and all other than the semicircular plate types also under U. S. Patent 1,258,423.





TYPE 287
DIRECT-READING OHMMETER



There are many occasions in laboratories, service stations and factories where an approximate measurement of resistance is required. The Type 287 Direct-Reading Ohmmeter is designed for the quick determination of resistance where an approximate value is sufficient.

The Type 287 Direct-Reading Ohmmeter consists of a battery and meter in series with a resistance, which protects the meter from damage at short circuit, and also provides a zero adjustment. The dial is calibrated directly in ohms. Clip leads are provided for convenience in connecting the instrument to the device to be measured.

One of the greatest uses of this ohmmeter is the checking of apparatus and tracing of circuits. Its indication of the actual resistance of the circuit makes the ohmmeter useful when the battery and telephone method of tracing circuits is of little use. This feature makes it possible to detect not only open and short circuits, but also wrong connections.

Before using the ohmmeter, the zero should be checked by connecting the terminals together. The knob should then be adjusted until the meter needle registers zero resistance (short circuit). The short-circuiting connection is then removed and the meter is ready for use. If the meter is to be shipped or stored for a considerable length of time the battery should be removed to prevent possible spilling with resultant injury to the cabinet. Price includes battery.

Type 287-A Direct-Reading Ohmmeter. Range 0 to 5000 ohms.. . \$30.00
Code Word: ONION.

Type 287-B Direct-Reading Ohmmeter. Range 0 to 2000 ohms.. . \$30.00
Code Word: ORBIT.

Dimensions 6 3/4" x 5 3/4" x 4 1/2". Weight 2 1/2 Ibs.





GENERAL RADIO PARTS AND ACCESSORIES



Type 127 A



Type 127 B



Type 127 C

TYPE 127 HOT-WIRE AMMETERS

The Type 127 Hot-Wire Ammeters are made in three types, the flush mounting for use on panels, the front-of-board mounting for use on switchboards, and the portable type for general use. These meters may be used for measuring filament currents, storage-battery charging rates, antenna radiation and have many other purposes.

Range		TYPE 127-A Flush Mounting CODE WORD	TYPE 127-B Front-of-Board CODE WORD	Price
100	Milliamperes	MEDAL	MAYOR	\$6.00
250	Milliamperes	MERCY	MADAM	6.00
500	Milliamperes	MERIT	MAJOR	6.00
1	Ampere	MERRY	MANOR	6.00
1.6	Amperes	MINUS	MISTY	6.00
2.5	Amperes	MINOR	MAPLE	6.00
5	Amperes	MINIM	MATIN	6.00
10	Amperes	MINNY	MAXIM	6.00
Galvanometer		MITER	MAGIC	5.75

Dimensions 8" x 1 1/2" Weight 9 1/2 oz.

Range		TYPE 127-C Code Word	Case	Price
100	Milliamperes	MUGGY	Portable	
280	Milliamperes	MOCHA	Portable	
500	Milliamperes	MOGUL	Portable	6.50
1	Ampere	MOLAR	Portable	6.50
2.5	Amperes	MOTOR	Portable	6.50
8	Amperes	MUMMY.	Portable	6.50
10	Amperes	MUSTY	Portable	6.50
Galvanometer		MOTTO	Portable	6.25

Dimensions 8" x 3 3/4" x 1 1/2". Weight 8 oz.



The UNIVERSAL STANDARDS of RADIO

**TYPE 371
POTENTIOMETERS**



The Type 371 Potentiometers are supplied for panel mounting in the following resistances:

Resistance	Current	Code Word
5 Ohms	2.1 Amperes	RELAY
900 Ohms	150 Milliamperes	REDAN
2500 Ohms	90 Milliamperes	REFIT
4500 Ohms	65 Milliamperes	ROTOR
9000 Ohms	45 Milliamperes	ROWDY
18000 Ohms	35 Milliamperes	RULER

Type 371 Potentiometer \$5.00

Dimensions 3 1/2" x 3 1/2" Weight 7 oz.

The Type 371-T Tapered Potentiometer provides a variation in the rate of change of resistance over the range of the instrument. The Type 371-T Tapered Potentiometer is supplied in a 9000-ohm range only.

Type 371-T Tapered Potentiometer \$6.00

Code Word: SULLY.

RHEOSTATS



Type 214



Type 410



Type 301

TYPE 410 RHEOSTATS

The Type 410 Rheostat is of the single hole mounting type. The resistance unit is tightly wound on a specially treated nonabsorbent fiber strip. Genuine moulded bakelite is used for the base. A moulded bakelite knob is also provided. The shaft is 1/4" in diameter and the outside diameter of the bushings is 3/8". The length of the bushing is such that the rheostat may be easily mounted on panels up to 3/8" in thickness.

Resistance	Current	Code Word
0.5 Ohms	3.5 Amperes	SAVOR
1.5 Ohms	2.0 Amperes	SAXON
6 Ohms	1.0 Ampere	SABOT
12 Ohms	0.75 Ampere	SALON
25 Ohms	0.5 Ampere	SALTY 3

The Type 410 Potentiometer is of similar construction, but is provided with a third connection.

200 Ohms	175 Milliamperes	SATIN
----------	------------------	-------

Type 410 Rheostat or Potentiometer \$.100

TYPE 301 RHEOSTATS

The Type 301 Rheostat and Potentiometer are similar in general appearance and construction to the Type 410 Rheostat except that they do not possess the single hole mounting feature.

The Type 301 Rheostats are designed for baseboard as well as back-of-panel mounting.

Resistance	Current	Code Word
6 Ohms	1.0 Ampere	PALSY
12 Ohms	0.75 Ampere	REMIT
25 Ohms	0.5 Ampere	RENEW

The Type 301 Potentiometer is of similar construction, but is provided with a third terminal.

200 Ohms	175 MA.	REBUS
----------	---------	-------

Type 301 Rheostat or Potentiometer \$1.00
Dimensions 2" x 1 3/4" x 2 1/8". Weight 4 oz.

TYPE 214 RHEOSTATS

The Type 214 Rheostats are larger than the Type 301 Rheostats and are capable of a more accurate and gradual resistance control. These rheostats are made in two types, the Type 214-A Rheostat for back-of-panel mounting and the Type 214-B Rheostat for table mounting.

Resistance	Current	Type 214-A Panel Mounting	Type 214-B Table Mounting
0.75 Ohm	4.0 Amperes	SHINY	SILLY
2 Ohms	2.5 Amperes	RUDDY	RUMOR
7 Ohms	1.5 Amperes	RURAL	RUSTY
20 Ohms	0.75 Ampere.	RAZOR	READY
50 Ohms	0.5 Ampere	RAPID	RAVEL

The Type 214 Potentiometer is of similar construction but is provided with a third terminal.

400 Ohms	175 MA.	ROSIN	ROWEL
----------	---------	-------	-------

Type 214 Rheostats \$ 1 . 5 0

Type 214 400-ohm Potentiometer \$1.75

Dimensions 3" dia. x 2 1/4". Weight 7 oz.

A rheostat of 2500 ohms is also supplied in this type for use as a variable biasing resistor in alternating-current-operated power amplifiers. This unit is capable of carrying 75 milliamperes.

Type 214-A 2500-ohm Rheostat \$2.25

Dimensions 3" dia. x 2 1/4". Weight 7 oz.

Code Word: SYRUP.

Type 214-B 2500-ohm Rheostat \$2.25

Dimensions 3" dia. x 2 1/4". Weight 7 oz.

Code Word: SYNOD.

TYPE 446 VOLTAGE DIVIDER

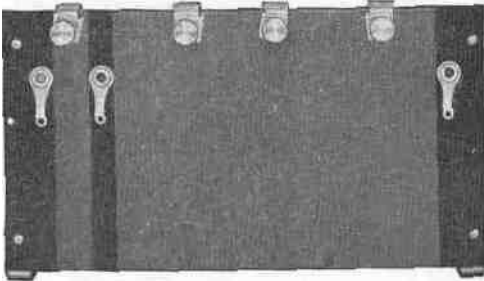

The Type 446 Voltage Divider has been especially designed for use as an output potentiometer device for 300-volt rectifying systems. It is wound in two sections, one of 15,000 ohms for the plate supply, and a 1500-ohm section for obtaining the bias voltage for a power tube. It is equipped with four adjustable sliders, suitably engraved, by means of which any combination of voltage may be obtained from the plate-supply unit. This unit will dissipate 60 watts. If intended for use with a 500-volt rectifying system two voltage dividers should be connected in series.

Type 446 Voltage Divider with four sliders \$2.75
 Dimensions 7 1/2" x 4 5/16" x 1 1/4". Weight 5 oz.
 Code Word: VISTA.

**CENTER-TAP
RESISTANCE UNITS**

In using alternating current, a means of obtaining the mid-potential point of the filament is required.



Type 439

The Type 439 Center-Tap Resistance is designed to be mounted directly across the filament or heater terminals of any tube socket by means of adjustable contact prongs.

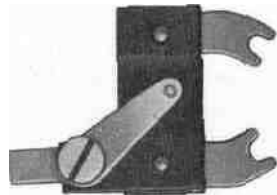

Type 437

This unit provides the center tap of the filament in circuits requiring such a connection. It has a total direct-current resistance of 60 ohms (i. e., 30 ohms on each side of the center tap) and is capable of carrying 200 milliamperes without excessive heating.

Type 439 Center-Tap Resistance \$.35
 Dimensions 1 1/2" x 1 1/4" x 5/8" Weight 1 oz.
 Code Word: PASTY.

Conditions often arise, due to unbalancing, when it is desirable to have a tap slightly off center across the filament of tubes having their filaments lighted by alternating current. The Type 437 Adjustable Center-Tap Resistance is similar to the Type 439 Center-Tap Resistance except that the tap is made by means of an adjustable slider. This enables the tap to be placed at a neutral point, thus reducing hum to a minimum.

Type 437 Adjustable Center-Tap Resistance \$.50
 Dimensions 13/8" x 13/4" x 3/8". Weight 1 oz.
 Code Word: PERIL.

SOCKETS

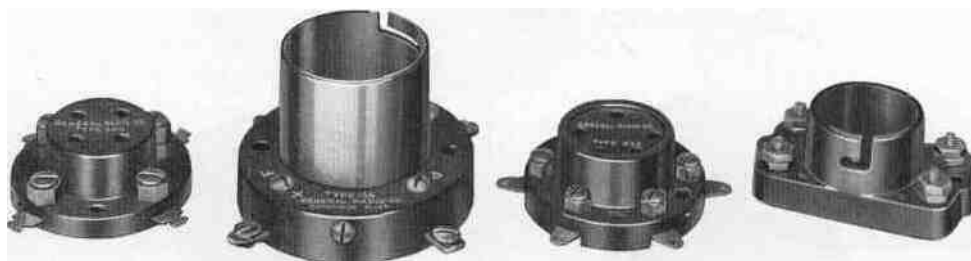

Type 349

Type 156

Type 438

Type 299

In the design of all General Radio Sockets, care has been taken in each case to make the sockets meet specifically the requirements of the tubes with which they are to be used. Moulded parts are of bakelite and metal parts are nickel-plated, with the exception of soldering terminals, which are tinned.

TYPE 156 SOCKET

This socket is designed for tubes having the large UV or UX-base. The phosphor-bronze contact springs are so arranged as to make positive contact on the sides of the tube prongs.

Type 156 Socket \$.75
 Dimensions 2 1/2" x 2 1/2" x 1 3/4". Weight 4 oz.
 Code Word: SOBER.

TYPE 299 SOCKET

The Type 299 Socket is designed for the UV-199 tube. A multiple spring makes contact to the bottom of the tube prongs.

Type 299 Socket \$.35
 Dimensions 2 3/8" x 1 3/8" x 1". Weight 2 oz.
 Code Word: STORY.

TYPE 349 SOCKET

This socket is designed for the UX-type of tube. Positive contacts are made with double gripping springs to the sides of the tube prongs.

Type 349 Socket \$.35

Dimensions 2 1/4" x 2 1/4" x 5/8". Weight 2 oz.

Code Word: SEDAN.

TYPE 438 SOCKET

The Type 438 Socket is designed for use with a tube having a five-prong base. Its construction is similar to the Type 349 Socket.

Type 438 Socket for UY-base tubes \$.35

Dimensions 2 1/3" x 2 1/2" x 3/4". Weight 2 oz.

Code Word: STUDY.

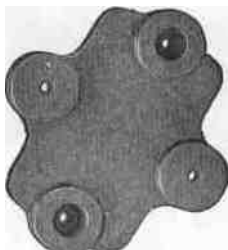

Type 309



Type 346

TYPE 346 ADAPTER

The Type 346 Adapter enables the UX-199 and UX-120 tubes to be used in standard tube sockets. The adapter is of moulded bakelite. A setscrew is provided for securing the tube firmly in the adapter.

Type 346 Adapter \$.20

Dimensions 1 1/2" x 1 1/2" x 7/8". Weight 1 oz.

Code Word: AMASS.

TYPE 309 SOCKET CUSHION

Many of the undesirable noises heard in a radio set are due to the microphonic action of the tubes. This condition may be somewhat reduced by the use of the Type 309 Socket Cushion under the Types 156, 299, 349 and 438 Sockets. This cushion is of sponge rubber.

Type 309 Socket Cushion \$.25

Dimensions 2 1/4" x 2 1/2" x 3/8". Weight 1 oz.

Code Word: SABER.

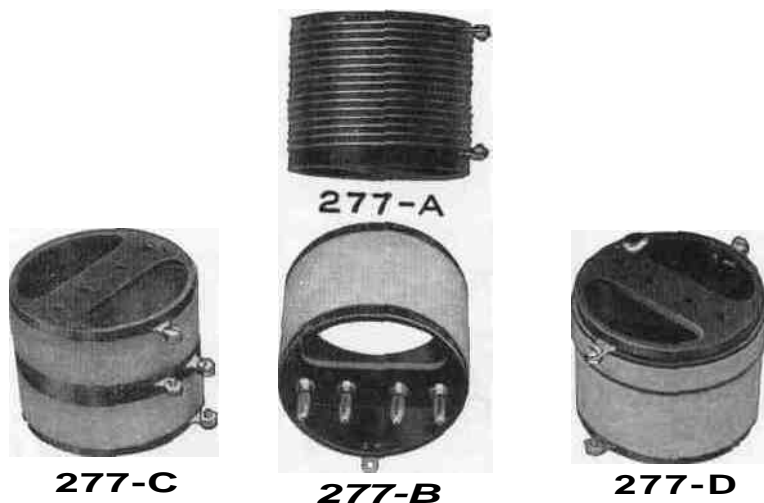

**TYPE 277
INDUCTANCE AND COUPLING COILS**

The Type 277 Inductance Coils are so shaped in ratio of diameter to length, the materials so chosen, and the construction such that they have very low losses. The forms are of moulded bakelite.

Models A, B and C have single windings and are wound in two sections so that the mid-point may be obtained or coupling turns added at the center point. Models D, D1/2, and D1/4 are coupling coils with a small primary winding.

Mounting holes are so arranged that the Type 274-P Plugs may be inserted and the coils used interchangeably in the Type 274 Mounting Bases.

Type	Wavelength with 500 MMF. Condenser	Inductance	Code Word	Price
277-A	50 to 150 Meters	14 Microhenrys	VALOR	\$1.00
277-B	100 to 300 Meters	55 Microhenrys	VAPID	1.00
277-C	200 to 600 Meters	217 Microhenrys	VENUS	1.00
277-D	Coupling Coil, 200 to 600 Meters	217 Microhenrys	VIGIL	1.15
277-D1/2	Coupling Coil, 100 to 300 Meters	55 Microhenrys	VIPER	1.15
277-D1/4	Coupling Coil, 50 to 150 Meters	15 Microhenrys	VILLA	1.15
277-U	Unwound Coil Form		VIGOR	.70

Dimensions 3 1/3" x 2 1/4". Weight 5 oz.

TYPE 268 VARIOCOUPLER

In experimental set-ups, variable inductors and variable couplers of small size are frequently required for the tuning of circuits.

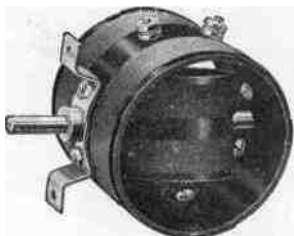

The stator inductance of the Type 268 Variocoupler is 380 microhenrys; the rotor inductance is 106 microhenrys. This instrument is especially compact and efficient in circuits which require a high-grade coupler.

Type 268 Variocoupler \$2.50

Dimensions 6 1/2" x 4" x 2 1/2"

CodeWord: VALET.

TYPE 269 VARIOMETER

The Type 269 Variometer is much smaller than the average variometer, which gives it a decided advantage when compactness and portability of the set are considerations. It is efficient electrically and has a maximum-to-minimum inductance range of 820-80 microhenrys.

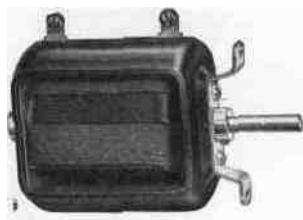

Type 269 Variometer \$3.50

Dimensions 4 3/4" x 3" x 1 3/4". Weight 7 oz.

Code Word: VALID.

TYPE 379 RADIO-FREQUENCY CHOKES

Radio-frequency chokes are used to offer a high impedance to radio-frequency currents in circuits operating at audio frequencies or on direct current.

The Type 379 Chokes are designed to offer a high radio-frequency impedance in the amateur and broadcast bands. The effective capacity does not exceed 4 MMF. at any wavelength between 20 and 640 meters. The case is of moulded bakelite. The electrical characteristics of the chokes are given in the following table.

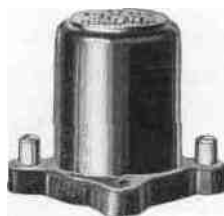

Type	Inductance	Current Rating	D.C. Resistance
379-T	8 Millihenrys	200 Milliamperes	34 Ohms
379-R	60 Millihenrys	90 Milliamperes	140 Ohms

Type 379-R Radio-Frequency Choke \$1.25

Code Word: JEWEL.

Type 379-T Radio-Frequency Choke \$1.25

CodeWord: JIMMY.

Dimensions, both types, 2" x 1 3/4" x 1 3/4". Weight 6 oz.





TYPES 260 AND 280 PORCELAIN INSULATORS

For antenna insulation, correctly designed porcelain strain insulators are to be preferred to other commercial types. The Type 280 Strain Insulator, illustrated, will be found particularly satisfactory. It is made of carefully glazed brown porcelain and will withstand severe weather conditions.

Type 280 Strain Insulator\$.12

Dimensions 4 1/2" x 1 1/8" x 1". Weight 4 oz.

Code Word: CRULLER.

Another convenient insulator is the Type 260 Wall Insulator. It may be used inside to support wiring or instruments, or may be used outside for supporting lead-ins or ground wires. Two of these insulators with a threaded rod connecting them make an excellent lead-in combination. Since they are also constructed of glazed brown porcelain they may be used either indoors or out.

Each insulator is equipped with nuts and washers assembled, as illustrated,

Type 260 Wall Insulator\$.20

Dimensions 2 1/8" x 2 1/8" x 2". Weight 4 oz.

Code Word: CONIC.

DIALS

The General Radio Dials are of brass, finished to resemble frosted silver, with graduated scale in black. The Type 302 and 303 Dials are provided with a specially designed vernier attachment, consisting of a fiber pinion mounted below the dial, and engaging with a gear behind the dial. The pinion is mounted on a floating arm, and is held in close contact with the gear by means of a spring. The pinion is mounted on the front of the panel, and but one mounting hole is required for the entire vernier attachment.

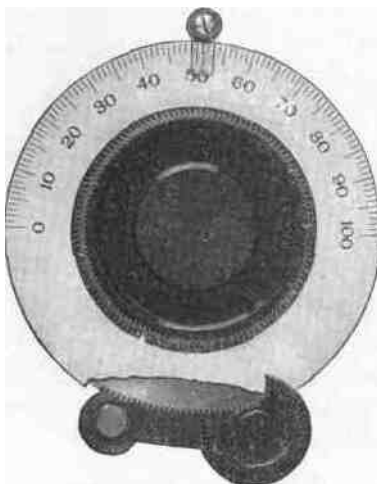

The Type 310 and 317 Dials are similar to the Type 302 and 303 Dials, but do not have the vernier attachment.

Each dial is packed with a celluloid indicator, and a template is provided for mounting. All dials are designed for a 14 inch shaft.

Type 302-23/4" Geared Dial	\$.125
Dimensions 45/8" x 3/4". Weight 10 oz.	
Code Word: DAISY.	
Type 303-4" Geared Dial	\$2.00
Dimensions 31/2" x 3/4". Weight 6 oz.	
Code Word: DALLY.	
Type 310-23/4" Dial	\$.50
Dimensions 23/4" x 5/8". Weight 31/2 oz.	
Code Word: DANDY.	
Type 317-4" Dial	\$ 1.00
Dimensions 4s" x 3/4". Weight 6 1/2 oz.	
Code Word: DEBUT.	

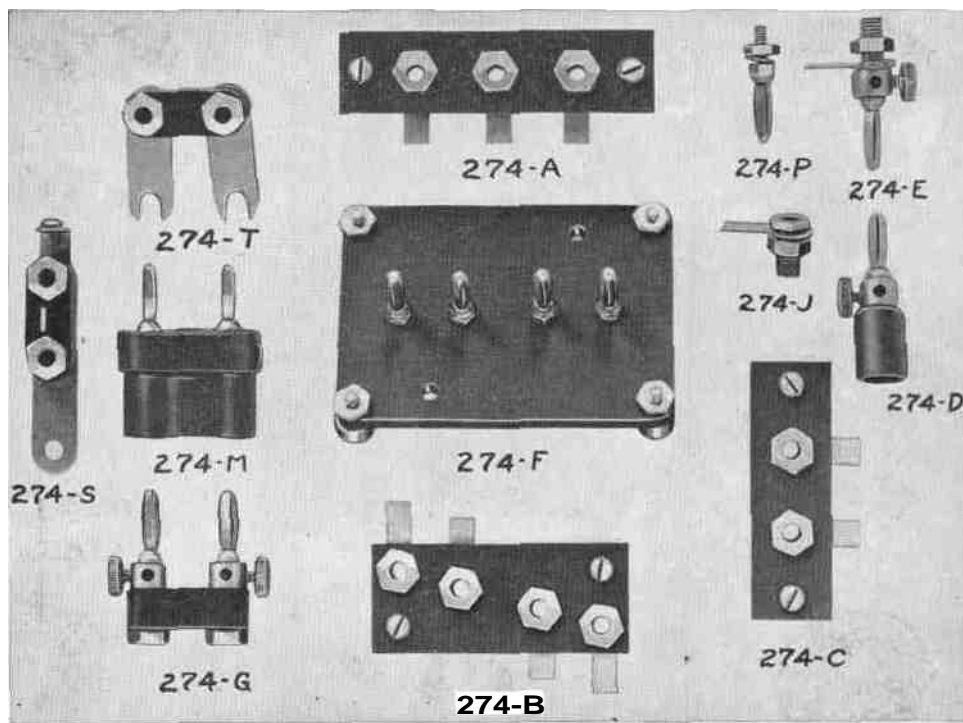

The experimenter will find the various items listed under the Type 274 group convenient for experimental work. This group consists of multiconnector plugs, jacks, plugs, transformer-mounting bases and coil-mounting bases. The various parts of this group will be found handy in comparing different methods of coupling either at radio or audio frequencies.

Type	Description	Price
274-A	3-Jack Base	\$.60
274-B	4-Jack Base	.65
274-C	2-Jack Base	.50
274-D	Single Insulated Plug	.25
274-E	Single Plug	.20
274-F	4-Plug Mounting Base	.75
274-G	Open Double Plug	.50
274-J	Jack	.05
274-M	Insulated Double Plug	.40
274-P	Plug	.06
274-R	4-Gang Plug	.50
274-S	Short-Circuit Jack	.50
274-T	Double Adjustable Jack	.50



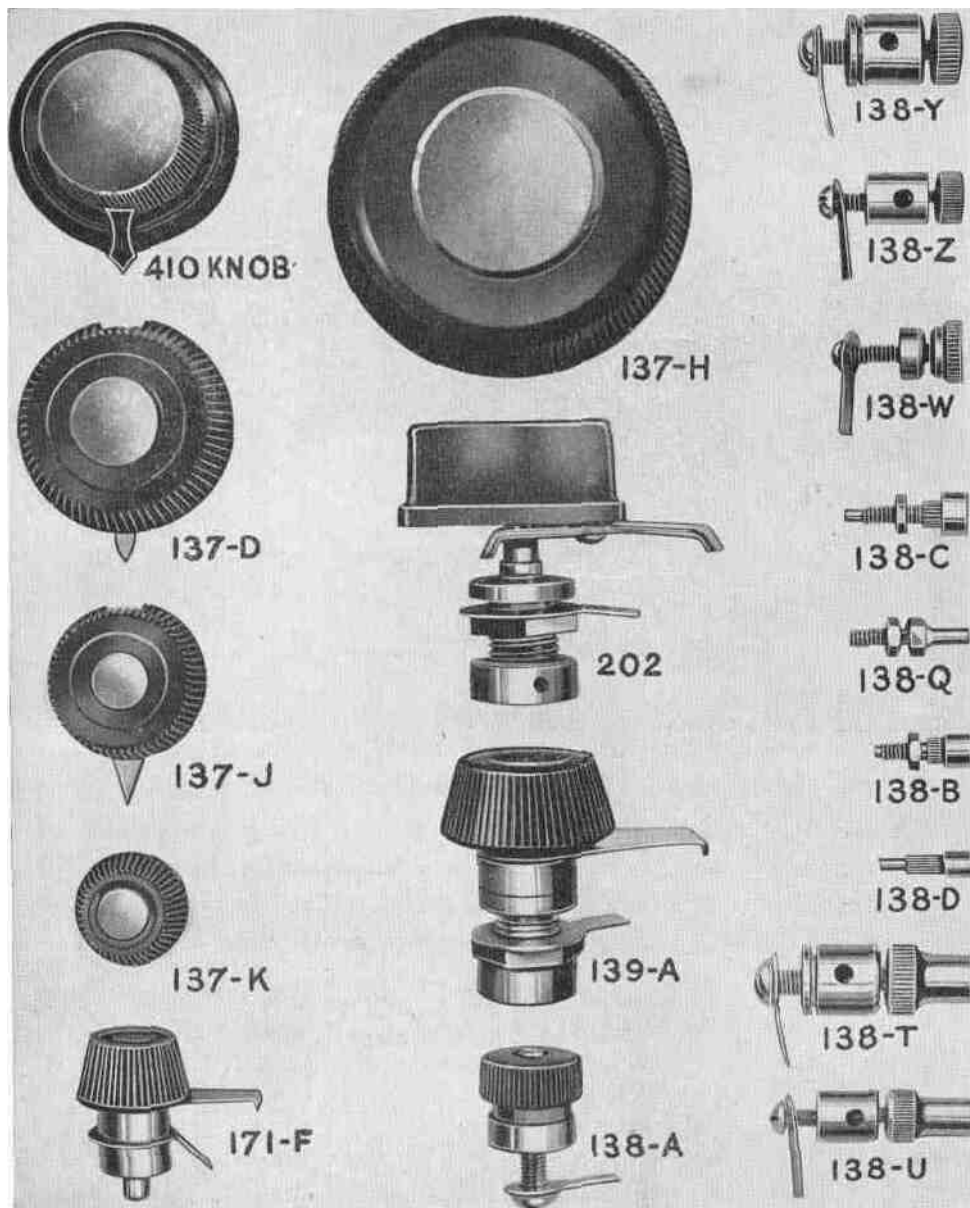

MISCELLANEOUS PARTS

All metal parts are nickel-plated. Knobs and other moulded parts are of bakelite.



BINDING POSTS

Type	Description	Diameter	Height	Screw Size	Price
138-A	Bakelite	3/4"	5/8"	10-32	\$.18
138-W	N. P. Brass	7/16"	1/2"	6-32	.08
138-Y	N. P. Brass	1/2"	3/4"	10-32	.14
138-Z	N. P. Brass	3/8"	5/8"	6-32	.07

SWITCH CONTACTS AND STOPS

Type	Description	Price
138-B	1/4" Contact for Type 171-F Switch	\$.04
138-C	5/16" Contact for Type 139-A or 202 Switch04
138-D	3/16" Contact for Type 171-F Switch03
138-Q	Switch Stop, with nut04

SWITCHES

Type	Description	Price
139-A	Multiple-Leaf Switch 13/8" Radius	\$.50
171-F	Single-Leaf Switch 7/8" Radius30
202	Low Contact Resistance Switch 1%" Radius75

KNOBS

Type	Description	Price
137-D	Moulded Knob, with pointer (same as used on Type 139-A Switch) ...	\$.30
137-D	Moulded Knob, without pointer25
137-H	Moulded Knob, (same as used on Type 317 Dial)50
137-J	Moulded Knob, with pointer (same as used on Type 310 Rheostat)20
137-J	Moulded Knob, without pointer15
137-K	Moulded Knob, (same as used on Type 247 Vernier)15

BINDING-POST TOPS

Type	Description	Price
138-T	Jack-Top Binding Post	\$.16
138-U	Jack-Top Binding Post10

TYPE 337 SWITCHES

The experimenter will find the Type 337 Switches convenient for experimental work. The construction is such that a quick change-over may be effected.

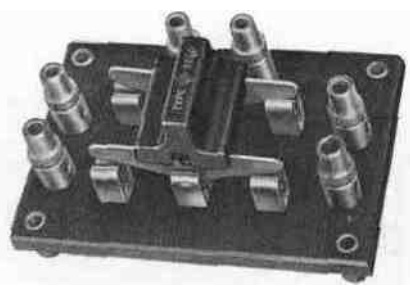

Type 337-A	DPDT Switch	\$ 3.00
Type 37-B	4PDT Switch	7.00
Type 337-C	6PDT Switch	10.00

In addition to the products listed in this Bulletin the General Radio Company manufactures many instruments for use in research and industrial laboratories, as well as standard frequency equipment for use in broadcast or commercial radio stations.

A partial list of these instruments includes:

Decade Condensers	Oscillograph
Precision Condensers	Audibility Meter
Wavemeters	Thermionic Voltmeter
Variometers	Standard-Signal Generator
Impedance Bridge	Decade Resistance Boxes
Capacity Bridges	Ratio Arm Box
Vacuum-Tube Bridge	Amplifier Test Set

The instruments manufactured by the General Radio Company are the result of careful engineering design. In many cases they represent the result of years of development work and investigation in the General Radio laboratories.

It has been the aim of this company to contribute only instruments of quality to the radio and electrical industry.

Every instrument is guaranteed.

This bulletin replaces Bulletin No. 930.

